



SHI-PRODUKTPASS

Produkte finden - Gebäude zertifizieren

SHI-Produktpass-Nr.:

14136-10-1000

Swegon CASA W3xs

Warengruppe: Technische Gebäudeausstattung / Sanitär - Lüftung



bluMartin GmbH
Argelsrieder Feld 1b,
82234 Wessling



Produktqualitäten:











Köttner

Helmut Köttner
Wissenschaftlicher Leiter
Freiburg, den 31.03.2026



Inhalt

 SHI-Produktbewertung 2024	1
 QNG - Qualitätssiegel Nachhaltiges Gebäude	2
 DGNB Neubau 2023	3
 DGNB Neubau 2018	4
 BNB-BN Neubau V2015	5
 EU-Taxonomie	6
 BREEAM DE Neubau 2018	7
 LEED v4.1	8
Produktsiegel	9
Rechtliche Hinweise	10
Technisches Datenblatt/Anhänge	11

Wir sind stolz darauf, dass die SHI-Datenbank, die erste und einzige Datenbank für Bauprodukte ist, die ihre umfassenden Prozesse sowie die Aktualität regelmäßig von dem unabhängigen Prüfunternehmen SGS-TÜV Saar überprüfen lässt.





Produkt:

Swegon CASA W3xs

SHI Produktpass-Nr.:

14136-10-1000



SHI-Produktbewertung 2024

Seit 2008 etabliert die Sentinel Holding Institut GmbH (SHI) einen einzigartigen Standard für schadstoffgeprüfte Produkte. Experten führen unabhängige Produktprüfungen nach klaren und transparenten Kriterien durch. Zusätzlich überprüft das unabhängige Prüfunternehmen SGS-TÜV Saar regelmäßig die Prozesse und Aktualität.

Kriterium	Produktkategorie	Schadstoffgrenzwert	Bewertung
SHI-Produktbewertung	sonstige Produkte	TVOC $\leq 300 \mu\text{g}/\text{m}^3$ Formaldehyd $\leq 24 \mu\text{g}/\text{m}^3$	Schadstoffgeprüft
Gültig bis: 11.09.2026			



Produkt:

Swegon CASA W3xs

SHI Produktpass-Nr.:

14136-10-1000



QNG - Qualitätssiegel Nachhaltiges Gebäude

Das Qualitätssiegel Nachhaltiges Gebäude, entwickelt durch das Bundesministerium für Wohnen, Stadtentwicklung und Bauwesen (BMWSB), legt Anforderungen an die ökologische, soziokulturelle und ökonomische Qualität von Gebäuden fest. Das Sentinel Holding Institut prüft Bauprodukte gemäß den QNG-Anforderungen für eine Zertifizierung und vergibt das QNG-ready Siegel. Das Einhalten des QNG-Standards ist Voraussetzung für den KfW-Förderkredit. Für bestimmte Produktgruppen hat das QNG derzeit keine spezifischen Anforderungen definiert. Diese Produkte sind als nicht bewertungsrelevant eingestuft, können jedoch in QNG-Projekten genutzt werden.

Kriterium	Pos. / Bauproduktgruppe	Betrachtete Stoffe	QNG Freigabe
3.1.3 Schadstoffvermeidung in Baumaterialien			QNG-ready nicht bewertungsrelevant



Produkt:

Swegon CASA W3xs

SHI Produktpass-Nr.:

14136-10-1000



DGNB Neubau 2023

Das DGNB-System (Deutsche Gesellschaft für Nachhaltiges Bauen) bewertet die Nachhaltigkeit von Gebäuden verschiedener Art. Das System ist sowohl anwendbar für private und gewerbliche Großprojekte als auch für kleinere Wohngebäude. Die Version 2023 setzt hohe Standards für ökologische, ökonomische, soziokulturelle und funktionale Aspekte während des gesamten Lebenszyklus eines Gebäudes.

Kriterium	Pos. / Relevante Bauteile / Baumaterialien / Flächen	Betrachtete Stoffe / Aspekte	Qualitätsstufe
ENV 1.2 Risiken für die lokale Umwelt, 03.05.2024 (3. Auflage)			nicht bewertungsrelevant

Kriterium	Pos. / Relevante Bauteile / Baumaterialien / Flächen	Betrachtete Stoffe / Aspekte	Qualitätsstufe
ENV 1.2 Risiken für die lokale Umwelt, 29.05.2025 (4. Auflage)	nicht zutreffend		nicht bewertungsrelevant



Produkt:

Swegon CASA W3xs

SHI Produktpass-Nr.:

14136-10-1000



DGNB Neubau 2018

Das DGNB-System (Deutsche Gesellschaft für Nachhaltiges Bauen) bewertet die Nachhaltigkeit von Gebäuden verschiedener Art. Das System ist sowohl anwendbar für private und gewerbliche Großprojekte als auch für kleinere Wohngebäude.

Kriterium	Pos. / Relevante Bauteile / Baumaterialien / Flächen	Betrachtete Stoffe / Aspekte	Qualitätsstufe
ENV 1.2 Risiken für die lokale Umwelt			nicht bewertungsrelevant



Produkt:

Swegon CASA W3xs

SHI Produktpass-Nr.:

14136-10-1000



BNB-BN Neubau V2015

Das Bewertungssystem Nachhaltiges Bauen ist ein Instrument zur Bewertung von Büro- und Verwaltungsgebäuden, Unterrichtsgebäuden, Laborgebäuden sowie Außenanlagen in Deutschland. Das BNB wurde vom damaligen Bundesministerium für Umwelt, Naturschutz, Bau und Reaktorsicherheit (BMUB) entwickelt und unterliegt heute dem Bundesministerium für Wohnen, Stadtentwicklung und Bauwesen.

Kriterium	Pos. / Bauprodukttyp	Betrachtete Schadstoffgruppe	Qualitätsniveau
1.1.6 Risiken für die lokale Umwelt			nicht bewertungsrelevant



Produkt:

Swegon CASA W3xs

SHI Produktpass-Nr.:

14136-10-1000



EU-Taxonomie

Die EU-Taxonomie klassifiziert wirtschaftliche Aktivitäten und Produkte nach ihren Umweltauswirkungen. Auf der Produktebene gibt es gemäß der EU-Verordnung klare Anforderungen zu Formaldehyd und flüchtigen organischen Verbindungen (VOC). Die Sentinel Holding Institut GmbH kennzeichnet qualifizierte Produkte, die diesen Standard erfüllen.

Kriterium	Produkttyp	Betrachtete Stoffe	Bewertung
DNSH - Vermeidung und Verminderung der Umweltverschmutzung		Stoffe nach Anlage C	EU-Taxonomie konform

Nachweis: Herstellererklärung vom 25.03.2025



Produkt:

Swegon CASA W3xs

SHI Produktpass-Nr.:

14136-10-1000



BREEAM DE Neubau 2018

BREEAM (Building Research Establishment Environmental Assessment Methodology) ist ein britisches Gebäudebewertungssystem, welches die Nachhaltigkeit von Neubauten, Sanierungsprojekten und Umbauten einstuft. Das Bewertungssystem wurde vom Building Research Establishment (BRE) entwickelt und zielt darauf ab, ökologische, ökonomische und soziale Auswirkungen von Gebäuden zu bewerten und zu verbessern.

Kriterium	Produktkategorie	Betrachtete Stoffe	Qualitätsstufe
Hea o2 Qualität der Innenraumluf			nicht bewertungsrelevant



Produkt:

Swegon CASA W3xs

SHI Produktpass-Nr.:

14136-10-1000



LEED v4.1

LEED (Leadership in Energy and Environmental Design) ist ein international anerkanntes Gebäudezertifizierungssystem des U.S. Green Building Council. Es zählt zu den weltweit am weitesten verbreiteten Nachhaltigkeitsstandards für Gebäude und wird insbesondere bei international ausgerichteten Projekten eingesetzt. LEED bewertet Gebäude ganzheitlich in Kategorien wie Energieeffizienz, Ressourcenschonung, Materialauswahl, Innenraumqualität und Standortqualität. Je nach erreichter Punktzahl werden die Zertifizierungsstufen LEED Certified, Silver, Gold oder Platinum vergeben.

Kriterium	Produktkategorie	Bewertung
EQ Credit: Low-Emitting Materials		nicht bewertungsrelevant



Produkt:

Swegon CASA W3xs

SHI Produktpass-Nr.:

14136-10-1000



Produktsiegel

In der Baubranche spielt die Auswahl qualitativ hochwertiger Materialien eine zentrale Rolle für die Gesundheit in Gebäuden und deren Nachhaltigkeit. Produktlabels und Zertifikate bieten Orientierung, um diesen Anforderungen gerecht zu werden. Allerdings besitzt jedes Zertifikat und Label eigene Prüfkriterien, die genau betrachtet werden sollten, um sicherzustellen, dass sie den spezifischen Bedürfnissen eines Bauvorhabens entsprechen.



Dieses Produkt ist schadstoffgeprüft und wird vom Sentinel Holding Institut empfohlen. Gesundes Bauen, Modernisieren und Betreiben von Immobilien erfolgt dank des Sentinel Holding Konzepts nach transparenten und nachvollziehbaren Kriterien.



Produkte mit dem QNG-ready Siegel des Sentinel Holding Instituts eignen sich für Projekte, für welche das Qualitätssiegel Nachhaltiges Gebäude (QNG) angestrebt wird. QNG-ready Produkte erfüllen die Anforderungen des QNG Anhangdokument 3.1.3 "Schadstoffvermeidung in Baumaterialien". Das KfW-Kreditprogramm Klimafreundlicher Neubau mit QNG kann eine höhere Fördersumme ermöglichen.



Produkt:

Swegon CASA W3xs

SHI Produktpass-Nr.:

14136-10-1000



Rechtliche Hinweise

(*) Die Kriterien dieses Steckbriefs beziehen sich auf das gesamte Bauobjekt. Die Bewertung erfolgt auf der Ebene des Gebäudes. Im Rahmen einer sachgemäßen Planung und fachgerechten Installation können einzelne Produkte einen positiven Beitrag zum Gesamtergebnis der Bewertung leisten. Das Sentinel Holding Institut stützt sich einzig auf die Angaben des Herstellers.

Alle Kriterien finden Sie unter:

<https://www.sentinel-holding.eu/de/Themenwelten/Pr%C3%BCfkriterien%20f%C3%BCr%20Produkte>

Wir sind stolz darauf, dass die SHI-Datenbank, die erste und einzige Datenbank für Bauprodukte ist, die ihre umfassenden Prozesse sowie die Aktualität regelmäßig von dem unabhängigen Prüfunternehmen SGS-TÜV Saar überprüfen lässt.



Herausgeber

Sentinel Holding Institut GmbH
Bötzingen Str. 38
79111 Freiburg im Breisgau
Tel.: +49 761 590 481-70
info@sentinel-holding.eu
www.sentinel-holding.eu

CASA W3 xs Genius

Technical catalogue



QUICK FACTS

- CASA Genius control system
- Demand-controlled humidity function as standard
- Automatic summer function and passive cooling
- Anti-frost protection ensures continuous ventilation
- External coils for heating and cooling as an option
- Can be connected to the automated building management system (I/O/Modbus, connection box as standard)
- Mounted on the wall or ceiling

UNIT TECHNICAL CONTENT

Air flow range	10-80 l/s 36-288 m ³ /h
Dimensions, w x l x h	597 x 599 x 446 mm
Duct outlets	4 x Ø 125 mm
Cooker hood outlet	Ø 125 mm
Energy calculations and acoustic data	procasa.swegon.com
Connection power	1240 W 1740 W
Power connection	230 V, 50 Hz, 10 A
Fans	220 W, EC
Filters	ISO ePM1 50% (F7) filter for supply air and ISO coarse (G3) for extract air
Colour	Exterior White, RAL 9016 (corresponds to NCS S0502-G50Y)

Content

Technical description	3
CASA Genius control	6
Design data	8
Air flows	10
Acoustic data	10
Dimensions and weight	11
Functional diagram	12
External connections	14
Internal connections.....	15
Installation options	16
Product codes	18



Technical description

Swegon CASA W3 xs Genius

Air handling unit with counterflow heat exchanger (597 x 599 x 446 mm, Ø 125 mm) suitable installation in homes (150 m²). The unit's sound level is low. The intelligent demand-controlled humidity function is standard.

Indoor environmental quality

Ventilation control

The unit is controlled steplessly with automation functions to guarantee the best indoor environmental quality. The user can select five operating modes home, away, boost, travelling and home+ by using control panel, cooker hood or Swegon CASA app. Operation modes can be automated with unit's weekly programs.

Temperature control

The supply air temperature is controlled with heat exchanger and if needed with optional heating or cooling element.

The unit has automatic summer time detection. The function sets lower supply air temperature setpoint and boost ventilation in order to bring more fresh outdoor air to the apartment during summer nights.



Available variants

Standard units are available in following variants:

- Unit with RH-sensor, connection power 1240 W
L (exhaust air left) / R (exhaust air right)
- Unit with RH- and CO₂-sensor, connection power 1240 W
L (exhaust air left) / R (exhaust air right)
- Unit with RH- and VOC-sensor, connection power 1240 W
L (exhaust air left) / R (exhaust air right)
- Unit with RH-sensor, connection power 740 W
L (exhaust air left) / R (exhaust air right)

Components

Fans

CASA W3 xs is equipped with energy efficient EC fans.

Filter

The ventilation unit is equipped with ISO ePM1 50% (F7) filter for supply air and ISO coarse (G3) for extract air. The need of filter replacement is indicated on the control panel and on the CASA cooker hood.

Heat exchanger

The ventilation unit is equipped with **a plate heat exchanger which is based on the counterflow technology**. The incoming and outgoing air flows in a counterflow plate heat exchanger use separate channels, and thanks to this the heat exchanger does not return any odours back into the room air. It also does not return moisture and is therefore very well suited to dwellings with high humidity (eg abundant sauna and laundry).

The heat exchanger operates with the best possible efficiency in all conditions. This is possible with the demand and learning defrosting technology, which steplessly controls the heaters. Intelligent defrosting never leads cold outdoor air past the heat exchanger, keeping the supply air temperature constantly at a comfortable level.

External connections

All connections can be made without opening the electrical box. Plug-in modules are available for external connections. Wide variety of IO functions are available.

The ventilation unit is equipped with In-build Modbus and connection box.

Modbus cabling can also be made easily with external cable (SEC) or module (SEM). Unit can be fully controlled with Modbus and all external IO's can be configured to Modbus usage.

Protective functions

The heat exchanger freeze protection

The defrosting function guarantees continuous ventilation and maintains units performance even during extreme conditions. If reheat can't maintain sufficient supply air temperature, the air flows are reduced.

The fan overheating protection

The fan overheat protection stops the fan if the temperature rises too high and is reseted automatically. If protection stops the fans an alarm is generated.

Electric air heaters

The electric heater is equipped with automatic and manual overtemperature protection. Overheat cuts the heating circuit and generates an alarm.

Cold supply air

The ventilation unit has built-in condensation protection. If the supply air is too cold, the ventilation unit stops and an alarm is generated

High temperature

If supply air or units internal temperature is detected dangerously high the unit is stopped and an alarm is generated.

Temperature sensors

If a sensor fault is detected, an alarm is generated. If the faulted sensor is critical the ventilation unit is stopped. The ventilation unit returns to normal mode once the fault has been corrected.

The delivery includes

- Ventilation unit
- Anti-vibration mountings (2 pcs.)
- Quick Guide
- Installation and commissioning instruction
- Product fiche

Standard connections

- Power cord with earthed plug (2 m)
- SEM connection module with cable (2 m)
- Modular cable with RJ9 connector (1.5 m)
- Freely configurable I/O contacts for connection of accessories (2 pcs.)

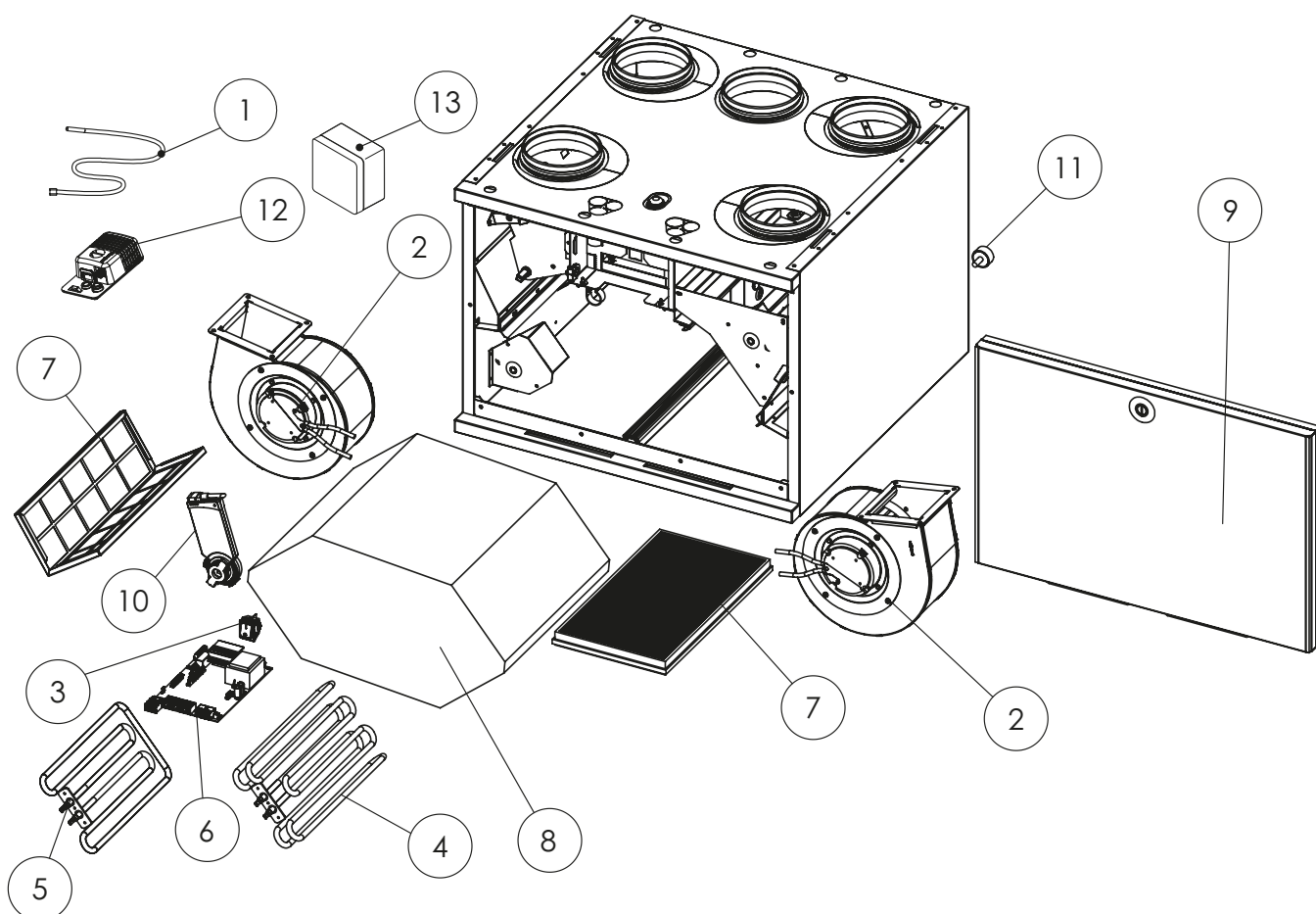

1. Temperature sensor
2. Fan (left + right)
3. Operating switch
4. Pre-heating module
5. Reheating module
6. Genius control board
7. Set of filters: ISO ePM1 50% (F7) for supply air, ISO coarse (G3) for extract air
8. Heat exchanger
9. Door
10. Damper motor
11. Anti-vibration mountings (2 pcs.)
12. Sensor package, RH
13. Connection box

Swegon CASA Genius

Intelligent control of the ventilation

With Swegon CASA Genius residents can monitor the indoor air quality (RH, CO₂, VOC, °C), adjust ventilation to their wishes or let the intelligent control to adjust ventilation automatically while saving energy and providing fresh and healthy indoor air.



The Swegon CASA control panel (GC10)

Wall-mounted touch screen for external or flush mounting. From the touch screen user can monitor ventilation, change ventilation mode, change the settings and commission the ventilation unit. The screen can be connected to the home WLAN, enabling the ventilation to be controlled remotely from a Swegon CASA mobile app



The Swegon CASA app

With Swegon CASA app residents can use all the control functions remotely from their own smartphone. Users get more information about their home's air quality as well as valuable instructions and advice about the ventilation (requires Swegon Genius control panel).



The CASA Service app

for quick and easy commissioning. The app works locally together with the ventilation unit and doesn't require connection to network. The app defines the I/O connections, presets the fan speeds that correspond to specified air volumes, as well as automatically sets air volumes for home and boost mode. Finished settings can be saved in the app and copied to the next apartment (requires Swegon Genius control panel).



Swegon CASA cooker hood

With cooker hoods, it is possible to control the ventilation unit's operating mode (home, away, boost), the cooker hood's shut-off damper and the lighting in the hood. The system balances the ventilation automatically when using the cooker hood.



The Swegon CASA HOME/AWAY/BOOST control switch (GC04)

Wall-mounted control switch for selecting boost, home and away modes.



Home automation

Can be connected to the home automation for centralised monitoring and control, either directly via configurable I/O or with the aid of a separate Modbus connection module (SEM).

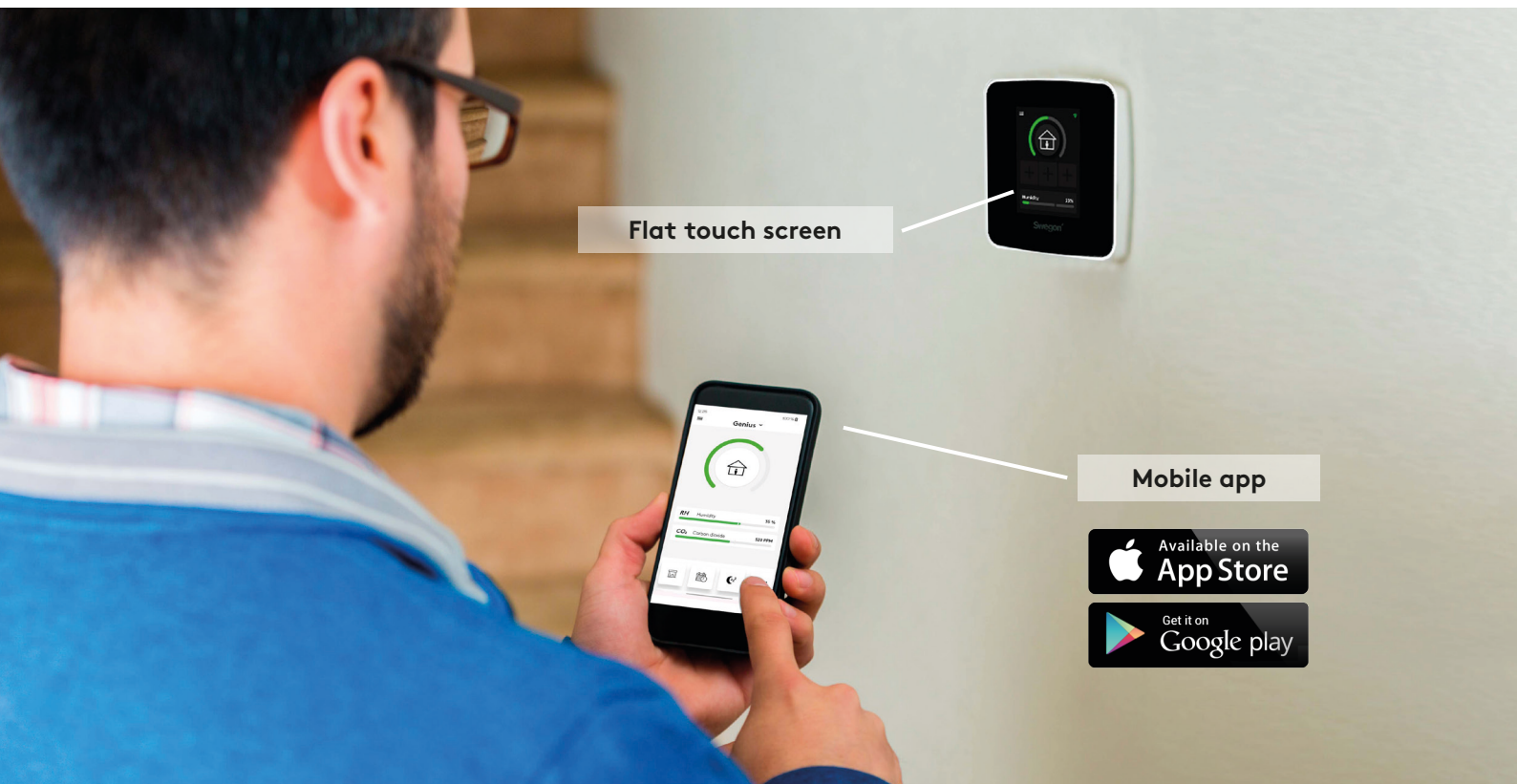

Flat touch screen

Mobile app





Basic modes

You can switch as required to an appropriate operating mode or let the pre-programmed weekly clock switch operating mode according to the diurnal rhythm you want.



Home

Normal air flow. Sufficient amount of fresh indoor air to ensure the wellbeing of the residents and the structural building elements when there are people in the home.



Home+

Higher air flow. Can be used when more ventilation is required. The home owner can change the efficiency of the operating mode from the settings.



Boost

High air flow. Used if the ventilation requirement increases, for example, when cooking, taking a bath or drying laundry, or when an unusually large number of people are in the home.



Away

Low air flow. Reduces the energy consumption when nobody is present in the home.



Travelling

Very low air flow and lower supply air temperature. Used when nobody is present in the home.

Automatic functions

The intelligent ventilation monitors the quality of the indoor air and adjusts the ventilation automatically.



RH Humidity

35%

Automatic RH system included as standard

Humidity automation removes damaging moisture. The intelligent control analyses the indoor air continuously and regulates the ventilation steplessly so that excess moisture is removed, for example when you are washing.



CO₂ Carbon dioxide

520 PPM

Automatic CO₂ system as optional equipment

Automatically lowers the ventilation and saves energy when nobody is in the home. When the residents are at home, the ventilation is automatically boosted to bring exactly the right amount of fresh air into the home.



VOC Air quality

950 PPM

Automatic VOC system as optional equipment

The automatic air quality system boosts the ventilation if pollution, odours or vapours (evaporating organic compounds) are detected in the indoor air.



Swegon CASA -liesikuvulta
voi ohjata ilmanvaihtoa



Design data

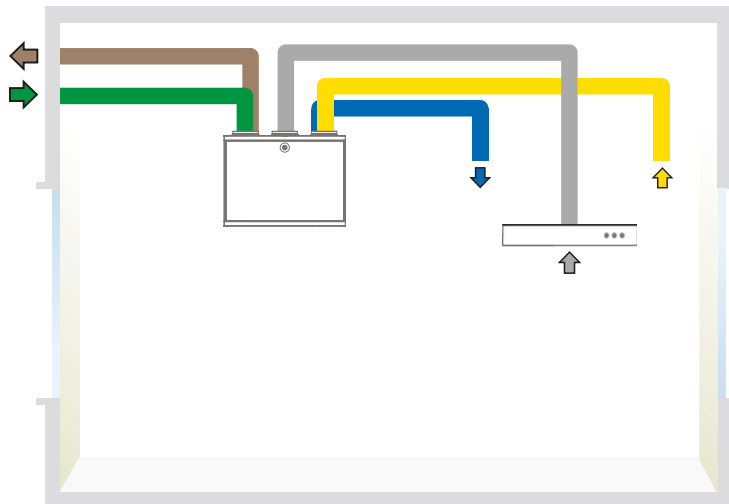

CASA W3 xs L, duct connections and cooker hood connected to the ventilation unit's kitchen duct connection.

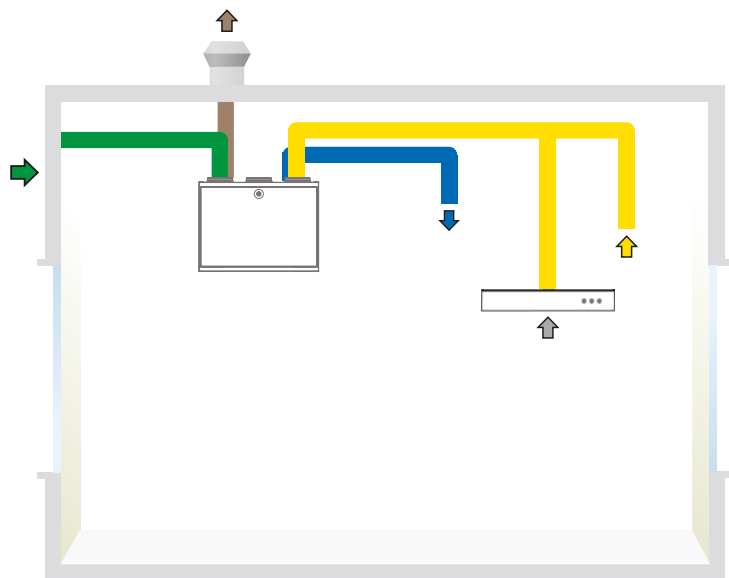

CASA W3 xs L, duct connections and cooker hood connected to the extract air duct.

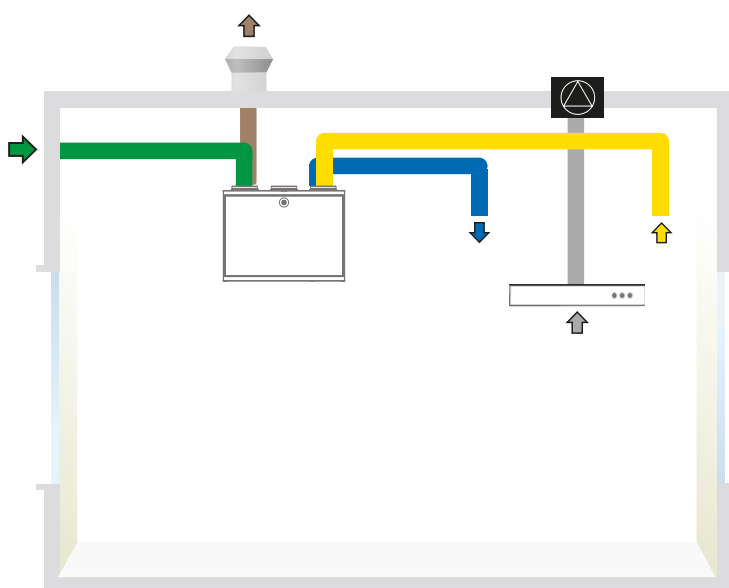

CASA W3 xs L, duct connections and cooker hood connected to external ceiling fan.



Outdoor air Supply air Extract air Exhaust air

Note! Always check the unit design (L/R) and correct duct sequence in the installation instructions.

ProCASA®

Energy calculation, functional diagram and acoustic data on ProCASA.

procasa.swegon.com

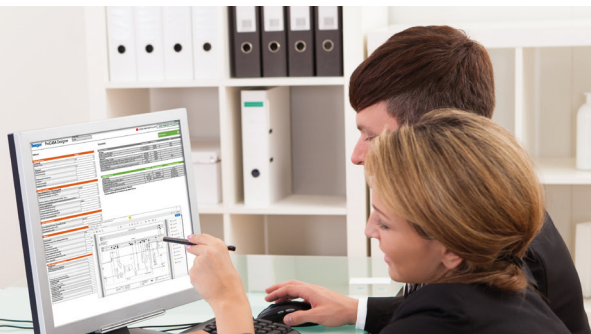

Energy calculator

Operating area

Select area
CAN - Ottawa

-33°C ... 28°C
Source: ASHRAE Fundamentals 2021

Select and print pages
 Energy calculation and dimensions

Project:

Customer:

Designed by:

Location:

Default values

Metric
l/s

Air flow: Supply air l/s, Extract air l/s

Duct pressure: Pa, Pa

Cooker hood airflow: l/s

usage time per day: h/d

Indoor temperature 21°C
Minimum supply air temperature (+10°C...+21°C)
+10 +11 +12 +13 +14 +15 +16 +17 +18 +19 +20 +21

Max airflow rate: l/s
Sound power level: dB(A)

*) Additional accessories may be needed

Fan power and energy use EN13141-7

Supply air	34 W
Extract air	34 W
SFP	0.45 W / (m³/h)
SFP	1.63 kW / (m³/s)
Annual energy use of fans	631 kWh

Energy used to heat the air EN13141-7

Reheating to 17 °C	314 kWh	367W peak load
Energy used without heat recovery	7016 kWh	
Annual energy efficiency for AHU (17 °C)	96 %	
Temperature efficiency of heat exchangers	84 %	
Temperature efficiency of air handling unit	80 %	

Acoustic data

Octave band (Hz)	63	125	250	500	1k	2k	4k	8k	L _{wa}
	L _w	L _w	L _w	L _w	L _w	L _w	L _w	L _w	L _w
Sound emitted to:	dB	dB	dB	dB	dB	dB	dB	dB	dB(A)
supply air duct	81	74	68	64	61	57	49	39	63
extract air duct	69	65	57	51	42	34	21	22	54
outdoor air duct	71	66	58	47	43	31	21	22	54
exhaust air duct	74	74	69	65	61	56	48	36	67
kitchen bypass duct	64	65	57	52	46	38	33	19	54
surroundings	49	50	42	35	35	17	0	15	40
surroundings at -6dB sound attenuation	L _{pa} dB(A) 36								

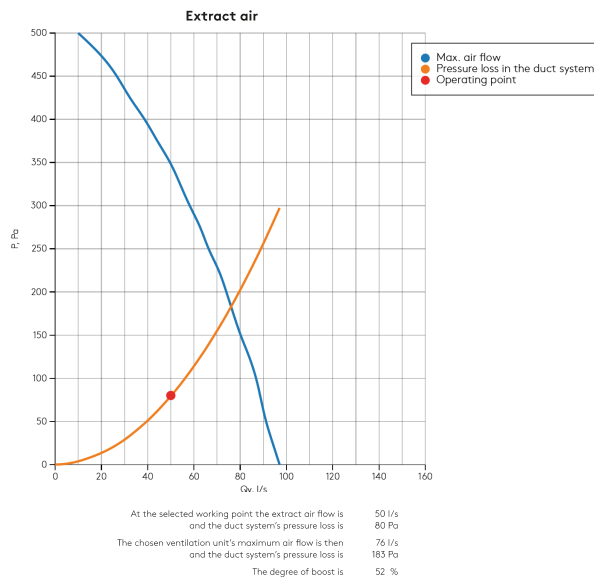
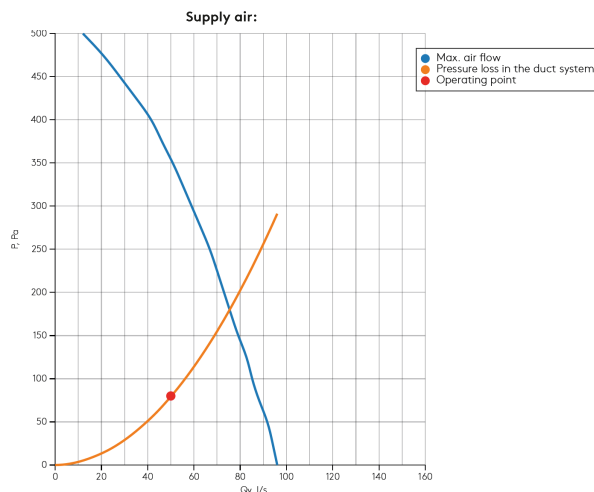

MagiCAD

3D models and CAD dimension sketches for all Swegon CASA products are available from MagiCloud. You can download DXF files directly from MagiCloud or use a MagiCAD plugin to transfer dimension sketches to the Revit and AutoCAD software packages.

www.magicloud.com



Air flows

Air flows EN 13141-4

W3 xs

- Supply airflow
- - - Extract airflow

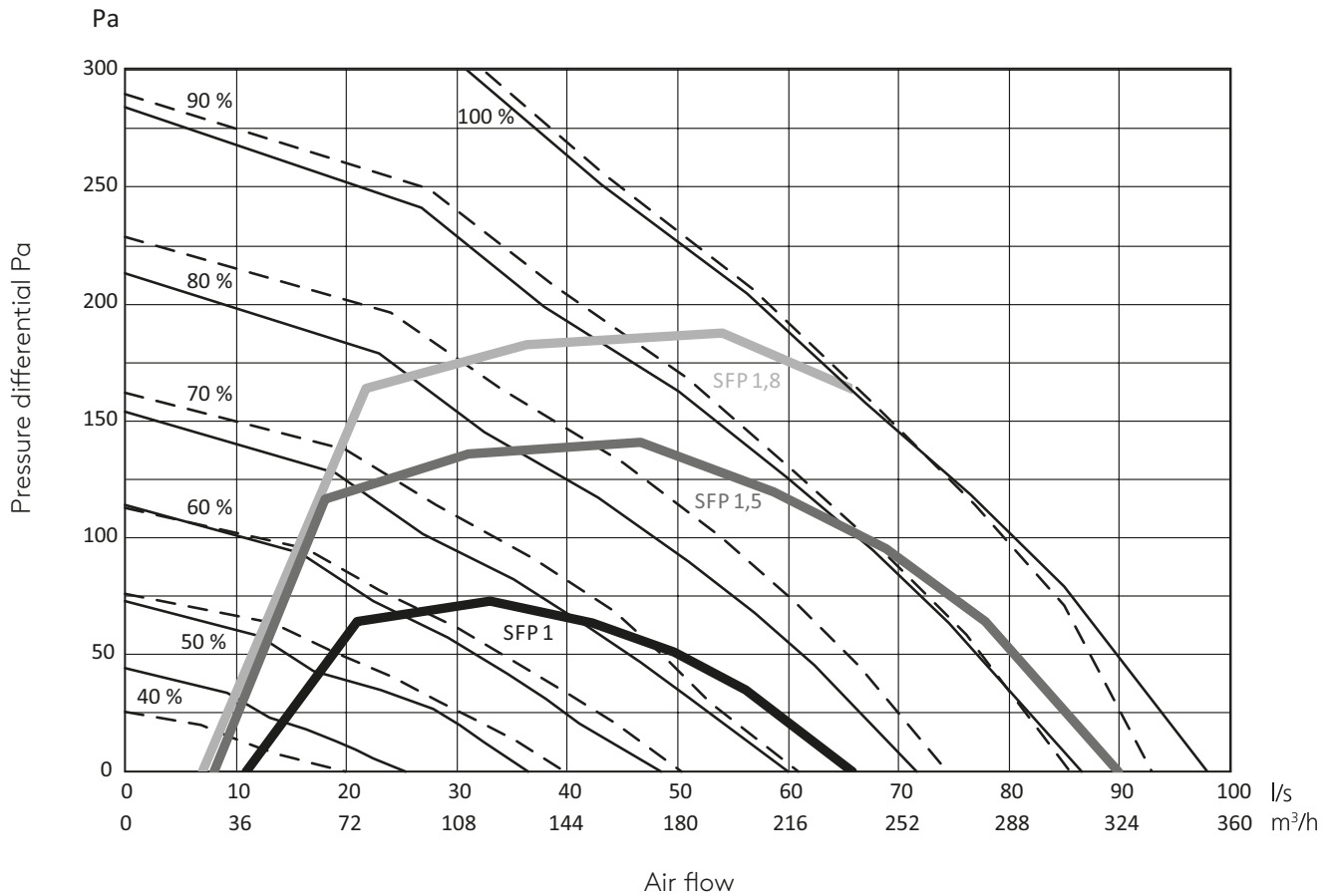

Acoustic data

See acoustic data on ProCASA.

procasa.swegon.com





Dimensions and weight

Dimensions

W3 xs

Weight of the unit: **45 kg**

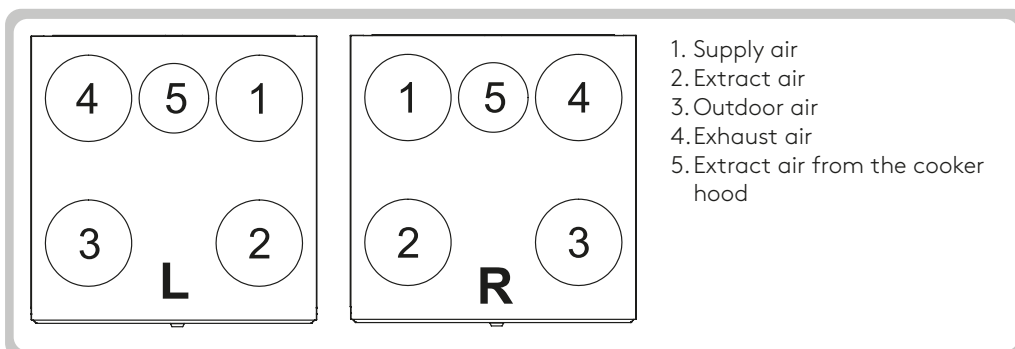
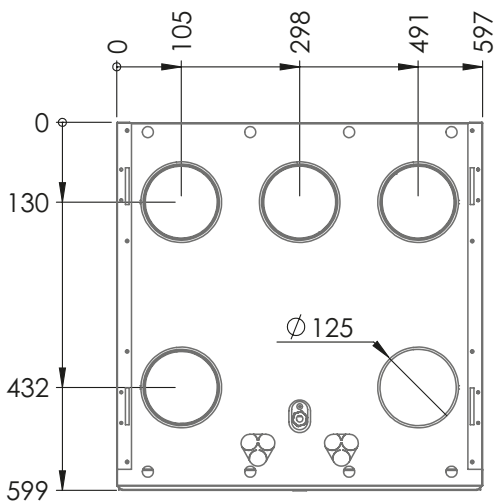
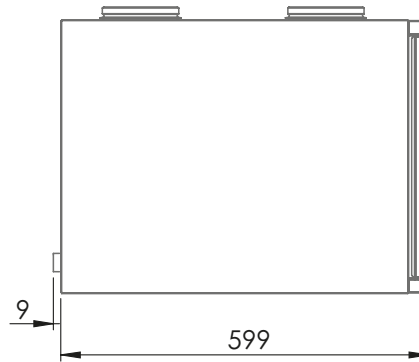
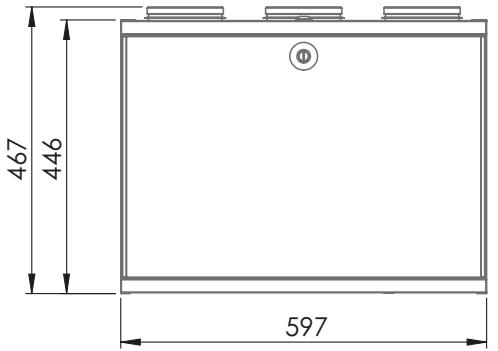
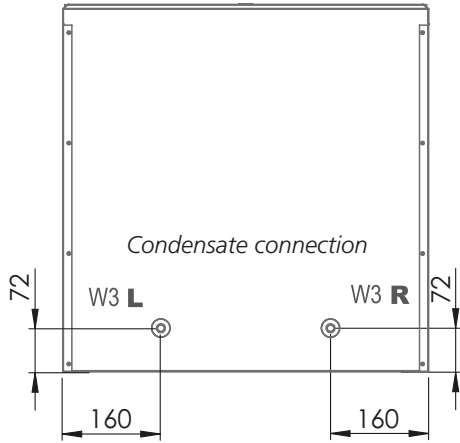



Functional diagram

Functional diagram

W3 xs

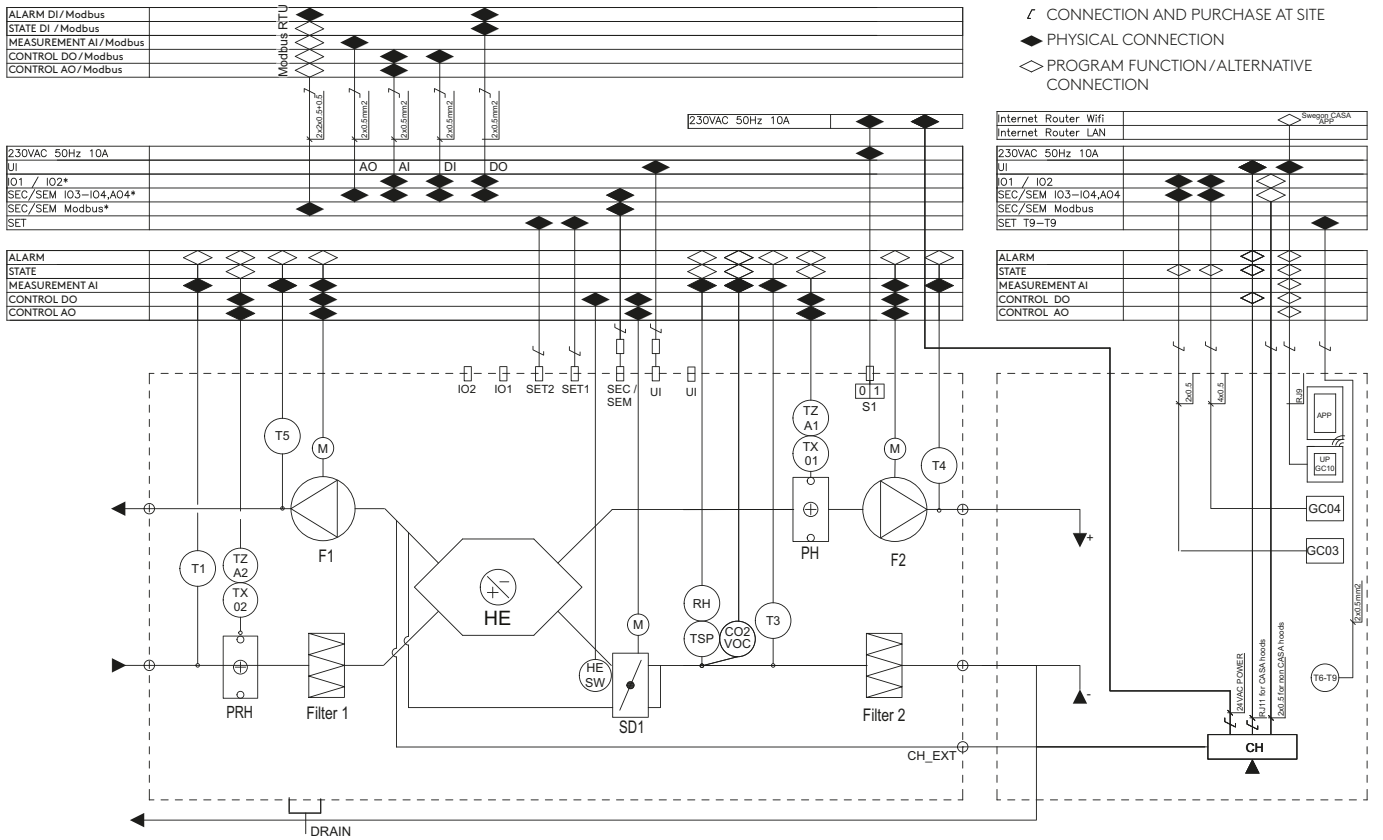

Device	Description	Modbus register
T1	Temperature sensor, outdoor air	3x6201 (0,1°C)
T3	Temperature sensor, extract air	3x6204 (0,1°C)
T4	Temperature sensor, supply air	3x6203 (0,1°C)
T5	Temperature sensor, exhaust air	3x6205 (0,1°C)
TZ01, TZ02	Manual overheat protection 70°C	Alarm 3x6117
TZA1, TZA2	Automatic overheat protection 55°C	Alarm 3x6117
Filter 1	Fresh air filters ISO ePM1 50% (F7)	Service reminder info 3x6129
Filter 2	Extract air filter ISO coarse (G3)	Service reminder info 3x6129
F1	Extract fan including internal overheat protection.	Control 3x6304 (%), RPM 3x6306
F2	Supply fan including internal overheat protection.	Control 3x6303 (%), RPM 3x6305
PRH	Pre heater, controlled steplessly according to demand	Control 3x6344 (%)
PH	Post heater, controlled steplessly according to demand. Ignored if the preheater is on.	Control 3x6317 (%)
HE	Heat exchanger	
SD1	Heat exchanger bypass damper and damper motor. Note, the wiring according to the handiness of the unit.	Control 3x6348 (%)
S1	Use Switch. Note! power off the unit by removing the socket from the Mains when Service	
RH	Humidity sensor for RH automation	RH 3x6214
TSP	Extract air temperature sensor for humidity measurement	
CH_EXT	Extra duct connection for the cooker hood. Duct bypasses the heat exchanger. Note! Do not connect the general ventilation of the kitchen here. Connect the hood status information to the ventilation unit. (Duct connection is plugged at the factory)	
DRAIN	Condensate discharge drain. Connect the water trap and drain hose to the condensate connection. Check the operation of the water trap.	

Functional diagram Duct actuators

- FIELD CONFIGURATION AU
- ∠ FIELD CONNECTION SU
- ◆ PHYSICAL CONNECTION
- ◇ ALTERNATIVE CONNECTION (Note: an additional relay is required for DO outputs)

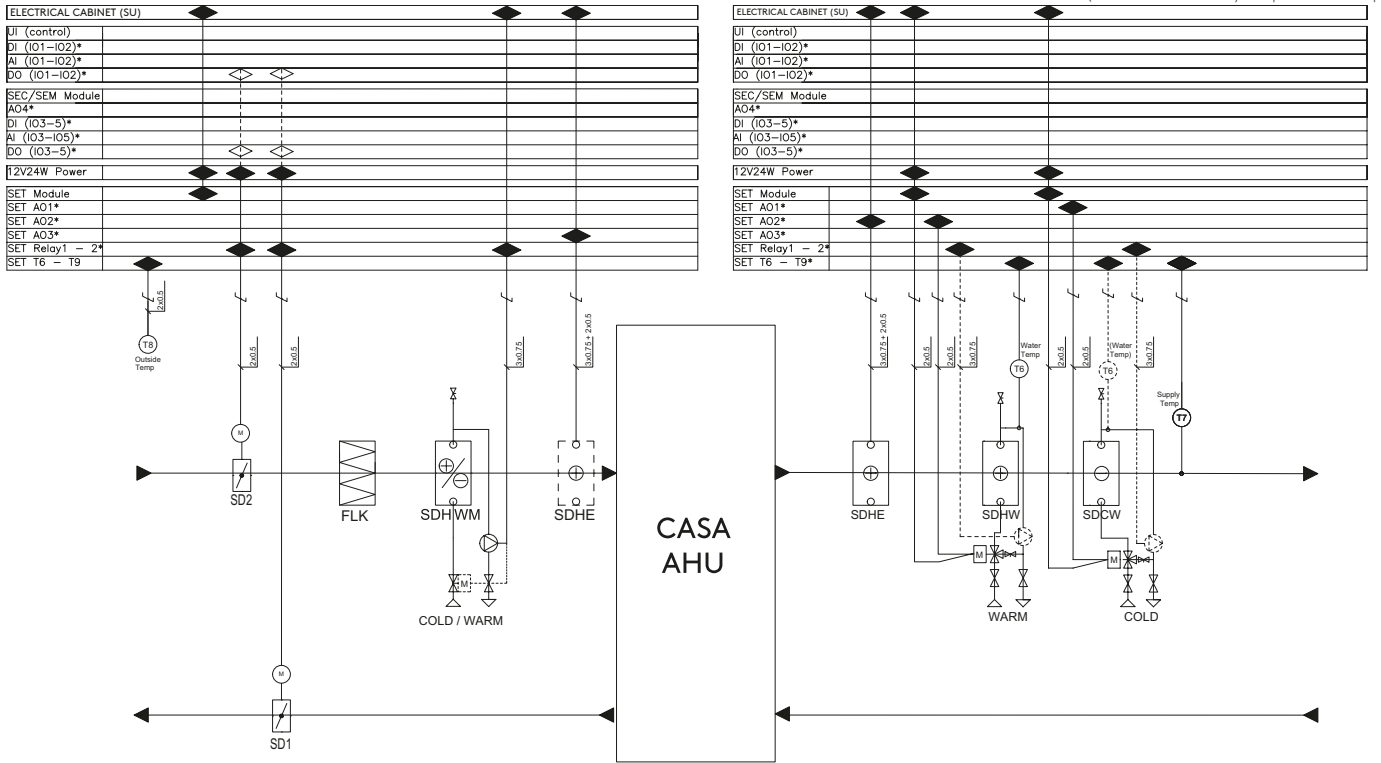

Device	Description
T6-T9	Temperature sensor. Connection to the SET module. The sensor must be defined on the control panel.
SD1, SD2	Duct Plate for Outdoor/Exhaust duct.
FLK	Duct filter in combination with an electric pre heater (SDHE)
SDHWM	Ground Liquid preheating/cooling coil for outdoor air duct. (Inc SET, heating/cooling coil, sensor)
SDHE	Electrical duct heater for Supply/Outdoor air duct (Inc. SET, duct heater and sensors) Note! A duct filter (FLK) is required for the preheater.
SDHW	Heating coil for supply air duct (Inc. SET, three-way valve + actuator, heating coil, sensors).
SDCW	Cooling coil for supply air duct (Inc. SET, three-way valve + actuator, cooling coil, sensors).
CO2	CO2 sensor for CO2 automation
VOC	VOC sensor for VOC automation
SEM	Modbus module (Inc. 2m RJ-45 cable)
SEC	IO extension module (Inc. 2m RJ-45 cable)
SET	Connection module for duct batteries and temperature sensors. (Inc. 2 x 3m RJ-45 cable)
APP	Swegon CASA mobile application for ventilation control and monitoring. Requires a Genius control panel (GC10) to operate.
UP GC10	Genius control panel that can be connected to Swegon CASA application via WiFi.
GC04	Control switch to select boost, home and away mode.
GC03	Control switch to select boost mode.
CH	Cooker hood. The CASA hood is connected to the ventilation unit with a modular cable. With other hoods, you can control the cooking function with a switch input that is determined for the function.



External connections

External connections CASA Genius

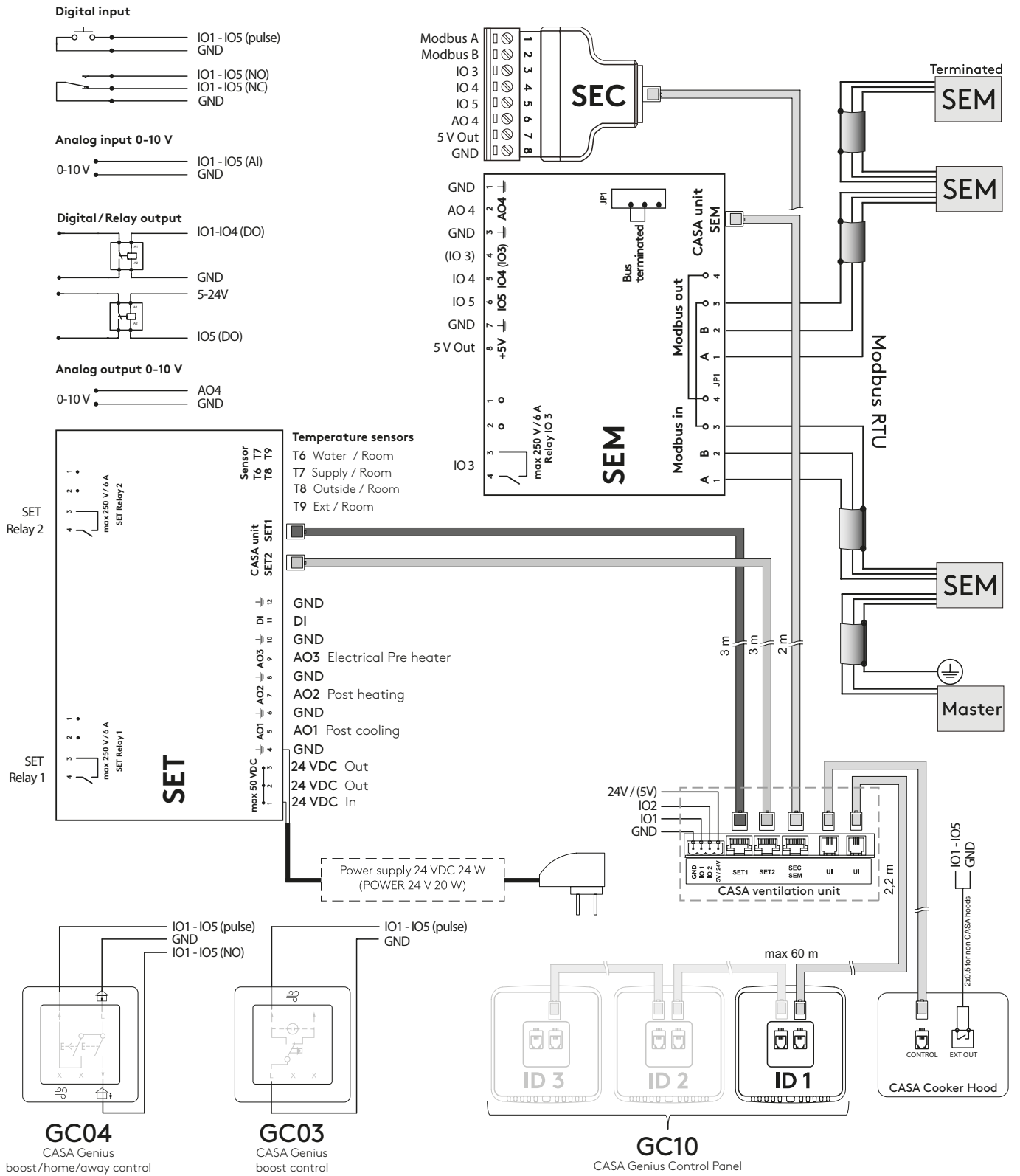

- SEC** IO extension cable with Modbus RTU
- SEM** IO extension module with relay and Modbus RTU (input and output connections)
- SET** IO extension module for control of external accessories

Internal connections

W3 xs

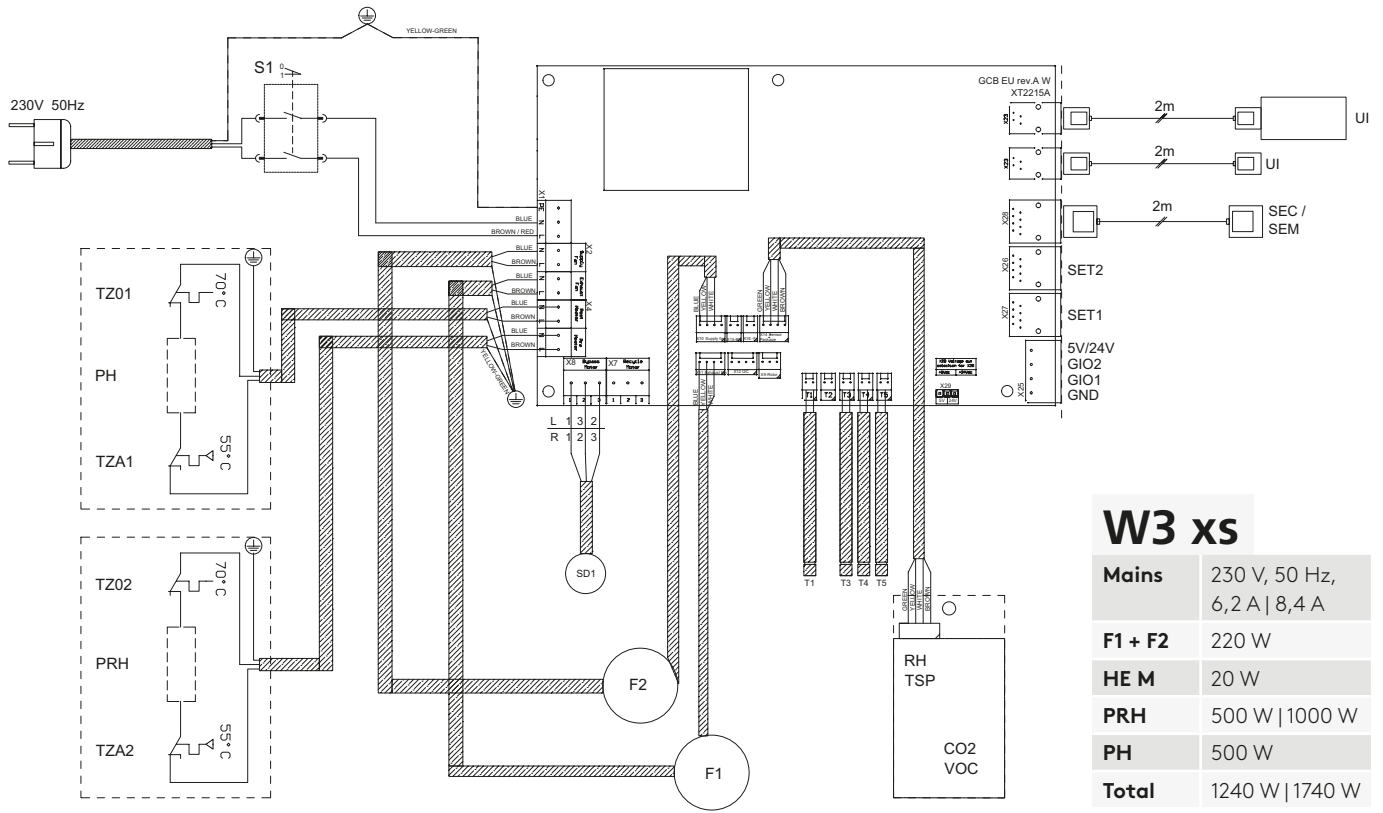

W3 xs	
Mains	230 V, 50 Hz, 6,2 A 8,4 A
F1 + F2	220 W
HE M	20 W
PRH	500 W 1000 W
PH	500 W
Total	1240 W 1740 W

Device	Description
T1	Temperature sensor, outdoor air
T3	Temperature sensor, extract air
T4	Temperature sensor, supply air
T5	Temperature sensor, exhaust air
PRH	Pre heater, controlled steplessly according to demand
PH	Post heater, controlled steplessly according to demand. Ignored if the preheater is on.
TZ01, TZ02	Manual overheat protection 70°C
TZA1, TZA2	Automatic overheat protection 55°C
F1	Extract fan including internal overheat protection.
F2	Supply fan including internal overheat protection.
SD1	Damper motor. Note, the wiring according to the handiness of the unit.
S1	Use Switch. Note! power off the unit by removing the socket from the Mains when Service
RH	Humidity sensor for RH automation
TSP	Extract air temperature sensor for humidity measurement
CO2	CO2 sensor for CO2 automation (accessory)
VOC	VOC sensor for VOC automation (accessory)
UI	Connectors for connecting the control panel and/or CASA cooker hood. One connection point is wired outside the unit.
SEC/SEM	Connector for connecting the SEC or SEM module. The connection point is wired outside the unit.
SET 1&2	Connectors for connecting the SET module
5V/24V	24V voltage output, which can be changed to 5V output with a jumper on the circuit board.
IO 1&2	Two general-purpose IO connectors. Connectors must be configured for the desired functions.
GND	Ground for IO connections.

Installation options

Ventilation unit installation site

The temperature in the space where the unit will be installed must be more than +10 °C. Due to the risk of disruptive noise, the ventilation unit should not be installed on the wall towards the living room or bedroom.

Wall mounting

A wall mounting bracket is an accessory.

If it is a question of a light partition wall, the wall must be reinforced with horizontal studs (A) that support the weight of the ventilation unit. In addition, Swegon also recommends that the wall be insulated with mineral wool or similar insulation (B) for preventing sound from propagating to other rooms.

Screw the wall mount firmly in horizontal position onto the wall where a wall stud will support the weight of the unit. Lift up the ventilation unit onto the wall mounting bracket so that the ears on the bracket engage in the corresponding notches at the top on the backside of the unit. Set the final position of the ventilation unit with the help of the adjustable anti-vibration mountings so that the ventilation unit tilts slightly backward.

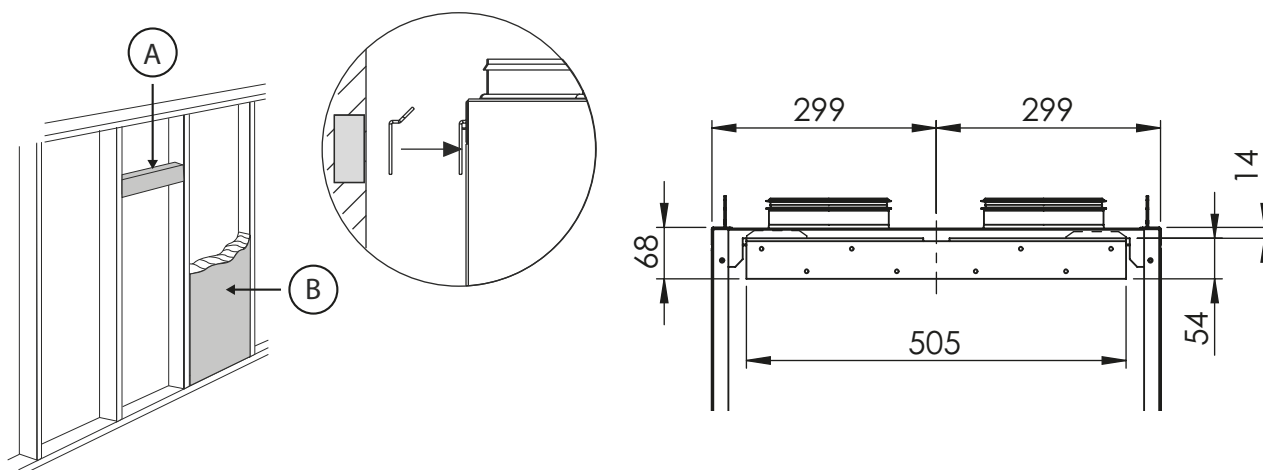

Ceiling mounting

The ventilation unit can also be mounted in a ceiling mounting frame (available as an accessory) on the ceiling.

The ceiling mounting frame must not be used as part of a support structure for the ducts, the duct support must be sufficient even without the support effect provided by the ceiling mounting frame.



Product codes

W3 xs

Product	Part no.	GTIN
W3xs Genius R 1240W A-bp RH MOD	W3SVR05G1YHA	6430080090365
CASA W3xs Genius L 1240W RH+CO2	W3SVL05G10CA	6430080090372
CASA W3xs Genius L 1240W Abp RH	W3SVL05G10HA	6430080090389
CASA W3xs Genius L 1240W RH+VOC	W3SVL05G10VA	6430080090396
CASA W3xs Genius L 740W Abp RH	W3SVL05GL0HA	6430080090419
W3xs Genius L 1240W A-bp RH MOD	W3SVL05G1YHA	6430080090433
CASA W3xs Genius R 1240W RH+CO2	W3SVR05G10CA	6430080090440
CASA W3xs Genius R 1240W Abp RH	W3SVR05G10HA	6430080090457
CASA W3xs Genius R 1240W RH+VOC	W3SVR05G10VA	6430080090464
CASA W3xs Genius R 740W Abp RH	W3SVR05GL0HA	6430080090488

Accessories

Product	Part no.	GTIN
Wall mounting bracket	WRWMB	6415879067438
Ceiling mounting frame	W03CMB	6415879068275
Cover plate for ceiling mounting frame, for flush mounting	W034CMP	6415879068299
Frame with sound trap	W034CNR	6415879069104
Mounting frame with vapour barrier	PW080YP	6415879066097
Water trap	UVLL	6415879069302
Condensate discharge tube	CDH3	6415879066776

CASA - Accessories

Control accessories	Part no.	GTIN
GC10 CASA Genius control panel and WiFi	GC10	6430080090846
GC10 control panel + 10 m long cable	GC14	6430080090853
GC10 control panel + 10 m long cable + frame	GC15	6430080090860
GC10 control panel + frame	GC16	6430080090877
Frame for control panel GC10	102SAK	6415879066752
CASA Genius boost/home/away control button	GC04	6430080090013

Building automation	Part no.	GTIN
Modbus connection module	SEM	6415879067346
Connection cable (configurable I/O) for Genius ventilation units	SEC	6415879067353
Room temperature sensor, total package with connection unit for ventilation units. The sensor is installed on the wall or in a recessed junction box (60 mm between holes).	WSTC	6415879069395

Automatic functions	Part no.	GTIN
RH + CO2 automation	SRHCO2	6415879066936
RH + VOC automation	SRHVOC	6415879066943

Waterborne air coolers	Part no.	GTIN
Cooling coil package Ø 160	SDCW160	6415879068053

Waterborne air heaters	Part no.	GTIN
Heating coil package Ø 125	SDHW125	6415879068039

Brine air heater/cooler for ground source heat pump	Part no.	GTIN
Heating/cooling coil Ø250, G4	SDHW250F	6415879068084

Electric air heater	Part no.	GTIN
Electric heater Ø 125	SDHE125-1T	6415879067230
Prefilter box Ø 125 mm, G4	FLK12	6415879067452

Duct mounted shut-off dampers	Part no.	GTIN
Damper Ø 125 mm	SDD125	6415879069890

Other accessories	Part no.	GTIN
Connection module for control of the duct mounted air heater/cooler / control of shut-off dampers	SET	6415879067339
SET / power source for actuators	POWER24V20W	6415879068404
PTH Regulation for constant duct pressure	PTH	6415879067285

Feel good **inside**



Swegon 